

- NOTES:**
1. Metal post and rails shall conform to ASTM F 689.
  2. Use Type 1 requirements from chain link fence table unless otherwise specified in the special contract requirements.
  3. Set all post in concrete. Set corner, end, pull posts to the dimension shown. The minimum depth of concrete for line posts is 24". Increase depth 3" for each additional foot of fence height over 4 feet.
  4. Install braces on all terminals on fences without a top rail. No braces are required on fabric 6 feet in height or less where a top rail is specified. Install braces where fabric is over 6 feet in height. Where a top rail is used, attach the brace at the halfway point of the terminal post above grade and, where the rail is omitted, at the two-thirds point above grade. Do not install top rail unless so specified in the special contract requirements.
  5. Adjust the post top elevations to provide a smooth visual fence profile. Install corner posts at horizontal breaks in the fence of 15° or more.
  6. If alternate steel posts are used, provide fastening bands, caps, brace rail, rail ends, and truss rod attaching hardware compatible with the post sizes and styles selected.
  7. Provide fence fabric with a 2" mesh. Use 11 gage wire in fabric heights of 48 inches or less and 9 gage wire in fabric heights greater than 48 inches. Provide a Class D coating when zinc-coated steel fence fabric is provided. Knuckle both selvages on fabric less than 72 inches high. For fabric 72 inches high or higher, Knuckle one selvage and twist the other.
  8. See Detail E619-09, sheet 2 for hardware and gate requirements.

**CHAIN LINK FENCE**

CHAIN LINK FENCE												
POST SIZE AND WEIGHT TABLE												
DESCRIPTION	FENCE TYPE	ROUND PIPE		HOT ROLLED SHAPE		ROLLED FORMED						
		Steel	Aluminum	Steel	Steel	Steel						
		Minimum yield strength Psi.										
		25,000	25,000	50,000	45,000	45,000						
Size and mass												
		dia. inch	mass lbs/ft	dia. inch	mass lbs/ft	dia. inch	mass lbs/ft	dia. inch	mass lbs/ft	dia. inch	mass lbs/ft	
Brace rail & top rail	Type 1	1.66	2.27	1.660	0.786	1.66	1.40	-----	-----	1 1/4 x 1 3/8	1.40	
	Type 2	1.66	1.82	-----	-----	1.66	1.40	-----	-----	1 1/4 x 1 3/8	1.40	
Line post	Type 1	2.375	3.65	2.375	1.264	2.375	3.12	2 1/4 x 1 45/64	3.26	2 1/4 x 1 3/8	2.70	
	Type 2	2.375	2.96	-----	-----	2.375	2.31	-----	-----	1 7/8 x 1 3/8	2.76	
End, corner & pull post	Type 1	2.875	5.79	2.875	2.004	2.875	4.64	-----	-----	3 1/2 x 3 1/2	5.10	
	Type 2	2.875	4.69	-----	-----	2.875	3.25	-----	-----	3 1/2 x 3 1/2	5.10	

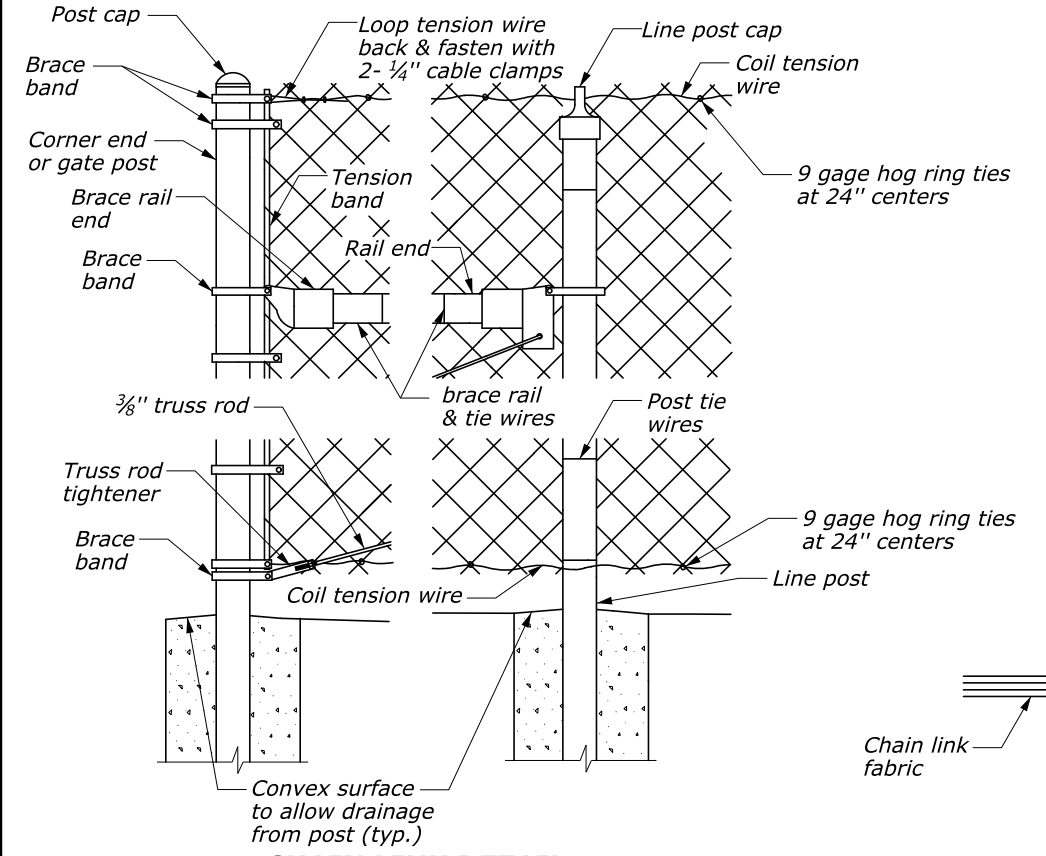

**CHAIN LINK DETAIL**

**CHAIN LINK FENCE TIE DETAIL**

**END OR CORNER POST**

**LINE POST**

**LINE POST**

**ALTERNATE STEEL POST & BRACE SECTIONS**

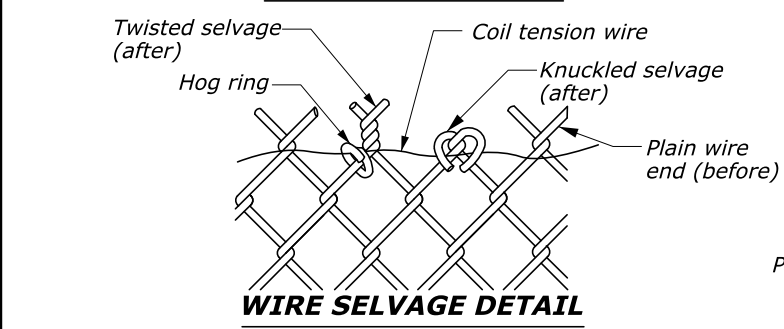

**WIRE SELVAGE DETAIL**

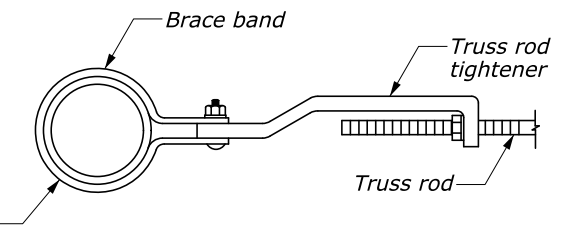

**TRUSS ROD TIGHTENER DETAIL**

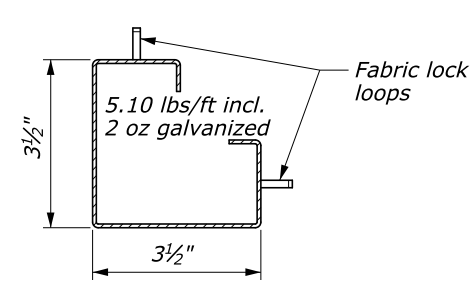

**END OR CORNER POST**

2.08 kg/m incl. 2 oz galvanized

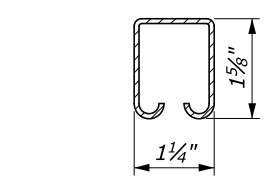

**TOP & BRACE RAIL**

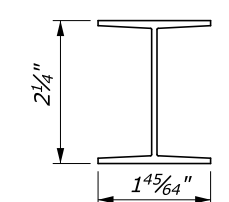

**LINE POST**

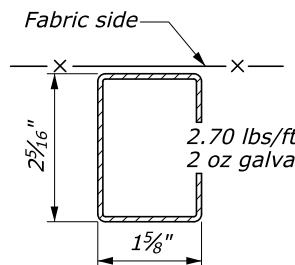

**LINE POST**

**ALTERNATE STEEL POST & BRACE SECTIONS**

NO SCALE

U.S. DEPARTMENT OF TRANSPORTATION  
 FEDERAL HIGHWAY ADMINISTRATION  
 EASTERN FEDERAL LANDS HIGHWAY DIVISION  
 U.S. CUSTOMARY DETAIL

**CHAIN LINK FENCE**

Sheet 1 of 2

DETAIL APPROVED FOR USE

DETAIL

APPROVED: MAY 2011  
 REVISED: SEPTEMBER 2014

E619-09

H:\Team\_Folders\VIDU\CFP\_14\_Detail\_Review\ALL\_FPH\_DCN\61909\_detail.dgn  
 01-Dec-2014 03:08 PM \$TIME\$

HARDWARE ITEM DESCRIPTION	STANDARD REQUIREMENTS
Brace rail and top rail 	See table on Detail E619-09
Line post 	See table on Detail E619-09
Corner; end and pull posts 	See table on Detail E619-09
Post cap 	Cast non-ferrous alloy or galvanized pressed steel cap must fit snugly on post and gate top
Line post cap 	Galvanized pressed steel minimum $\frac{3}{32}$ " thickness or galvanized malleable ferrous alloy
Tension band 	Minimum $\frac{3}{32}$ " x $\frac{5}{16}$ " galvanized steel
Brace band 	Minimum $\frac{3}{32}$ " x $\frac{5}{16}$ " galvanized steel
Band bolt 	Minimum $\frac{5}{16}$ " x $1\frac{1}{4}$ " galvanized carriage bolt, (Lock washer & flat washer for each band)
Rail end 	Galvanized pressed steel or galvanized malleable ferrous alloy minimum $\frac{3}{8}$ " thickness on back bolting appendage
Brace rail end 	Galvanized pressed steel or galvanized malleable ferrous alloy minimum $\frac{3}{8}$ " thickness on back bolting appendage
Truss rod tightener 	Minimum $\frac{1}{4}$ " formed galvanized steel
Truss rod 	$\frac{3}{8}$ " galvanized, NC threaded rod, lock washer, & flat washer with two 90° bends opposite of threaded end
Top rail sleeve 	Galvanized steel 0.051" minimum thickness by 6" minimum length
Tension bar 	Minimum $\frac{3}{16}$ " x $\frac{3}{4}$ " galvanized steel
Fence fabric 	2" diamond mesh fabric, See note no. 4 on Detail E619-07 of Sheet 1
Tie wires 	Minimum 9 gage aluminum with one hooked end
Coil tension wire 	0.177" minimum diameter metallic coated wire
Gate latch 	Minimum $\frac{1}{8}$ " galvanized pressed steel or malleable ferrous alloy. 1 latch per each single gate with bent minimum $\frac{3}{8}$ " attachment bolt, washer & nut.
Frame hinge 	Minimum $\frac{1}{8}$ " galvanized pressed steel with 2 - $\frac{3}{8}$ " U-bolts, lockwasher & nuts per hinge. Use 2 hinges per gate leaf up to 8' in width and 3 hinges per gate leaf widths greater than 8'.
Drop rod latch & guide 	Minimum $\frac{1}{8}$ " galvanized pressed steel. Drop rod guide includes $\frac{3}{8}$ " x 3" carriage bolt with lock washer & nut. Weld drop rod fork to rod & paint with an approved zinc rich paint.

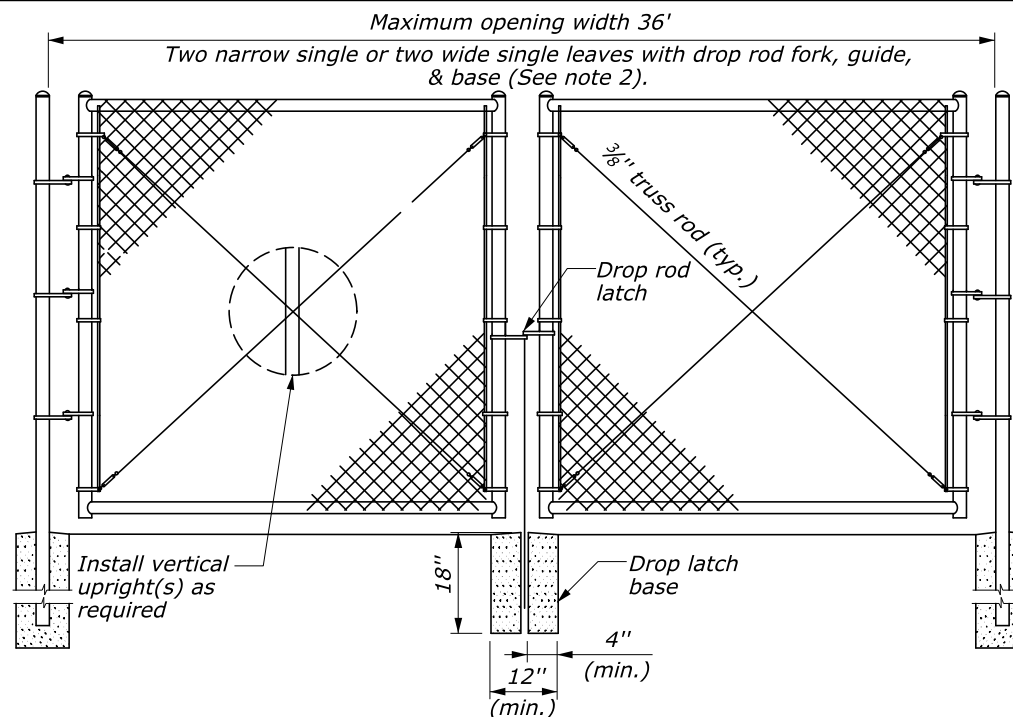

**DOUBLE LEAF GATE**

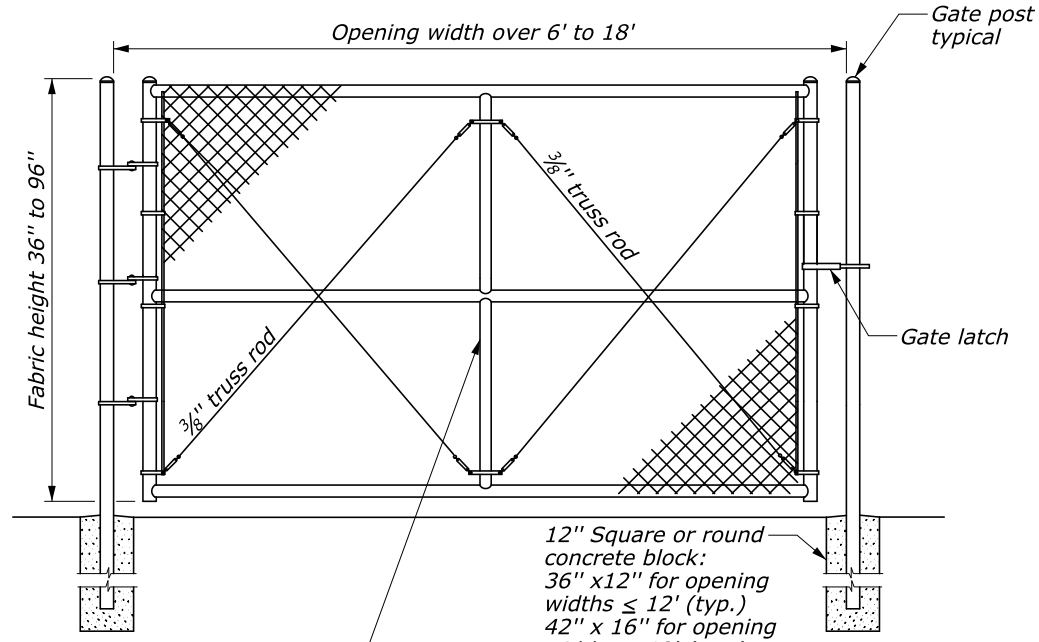

**WIDE SINGLE LEAF GATE**

Install one vertical upright for opening widths 8 feet to 16 feet. For opening widths greater than 16 feet, install two vertical uprights.

NOTES:

1. Reinforce the gate frame corners with a malleable iron or pressed steel fitting designed for the purpose or shop weld the corners. Grind smooth all welds and paint each gate with the necessary hinges, latch, and drop rod locking device design for the type of gate posts and used on the project. Provide positive type latching devices with provisions for pad locking at all gates. Provide keepers to retain the gate in the open position.
2. Approved alternate gate frames constructed of steel section, other than pipe, may be used.
3. The design of the chain link hardware may vary from the details shown, however, all hardware and materials used in a single installation shall be uniform and compatible.

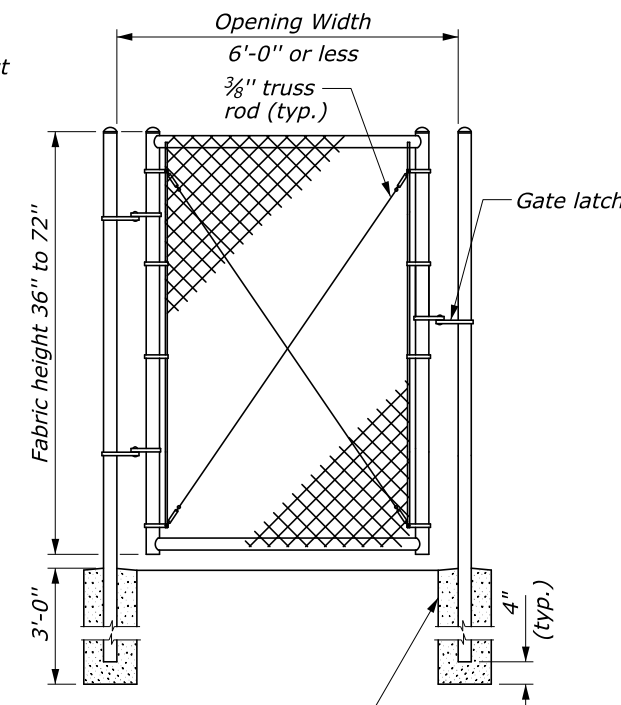

**NARROW SINGLE LEAF GATE**

CHAIN LINK GATE							
POST AND FRAME SIZE AND MASS TABLE							
GATE LEAF WIDTHS	Gate post size	ROUND PIPE					
		Steel		Aluminum		Steel	
		Minimum yield strength Psi.					
		25,000	25,000	50,000			
Size and mass							
		dia. inch	lbs/ft (min.)	dia. inch	lbs/ft (min.)	dia. inch	lbs/ft (min.)
6 feet or less		2.875	4.64	2.875	1.94	2.875	4.64
Over 6 feet to 12 feet		4.000	8.65	4.000	2.99	4.000	6.56
Over 12 feet to 18 feet		6.625	18.02	-----	-----	-----	-----
Outside frame member	frame size	1.900	2.28	1.900	1.900	1.900	2.28
Interior bracing member	frame size	1.660	1.83	1.900	1.900	1.660	1.84

NO SCALE

U.S. DEPARTMENT OF TRANSPORTATION  
FEDERAL HIGHWAY ADMINISTRATION  
EASTERN FEDERAL LANDS HIGHWAY DIVISION

U.S. CUSTOMARY DETAIL

**CHAIN LINK  
HARDWARE AND GATE**

Sheet 2 of 2

DETAIL APPROVED FOR USE

APPROVED : MAY 2011  
REVISED: SEPTEMBER 2014

DETAIL  
E619-09