

ATTACHMENT DETAIL For "R" Post

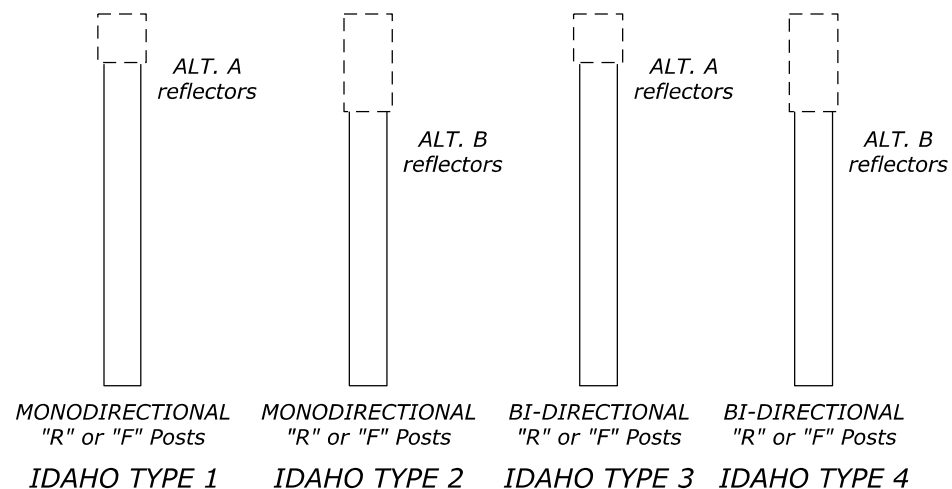

DELINEATORS

NOTE:

- Where delineators are used only on curves, place three delineators outside the curve limits.
- Place Type 3 delineators on the left side of two-way roadways at extreme curves with radii less than 300 m to the right. They may also be installed where it is not possible or practical to install and maintain right-hand delineation on both sides.
- If horizontal and vertical curves are combined, use the more restrictive spacing.
- Where delineators are used on tangents, space the delineators at 160 meters. Begin the tangent spacing beyond the spacing requirements for horizontal and vertical curves.
- Delineator reflector colors are shown in the plans. Delineator type includes the post type, for example: Type 1R or Type 3F, etc.
- When the contract does not provide for the construction of the ultimate pavement, allow for the thickness of base and pavement to be placed later when establishing the elevation of the traffic delineators.
- Vary the post spacing up to 1/8 of the spacing shown to clear driveways, cross roads, intersections or ramps. Eliminate the post if the variation is exceeded.
- Furnish hardware in the metric sizes shown. Equivalent US Customary sizes may be used when metric sizes are unavailable.
- Dimensions without units are millimeters.

REFLECTIVE SHEETING

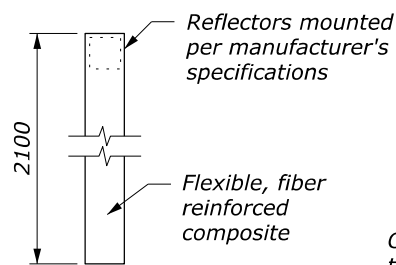

FLEXIBLE, SELF ERECTING OR YIELDING; WHITE UNLESS OTHERWISE NOTED
POST "F" DETAIL

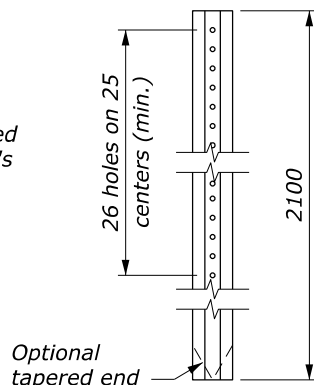

RIGID STEEL OR ALUMINUM (ALL HOLES 6.5 mm DIAMETER)
POST "R" DETAIL

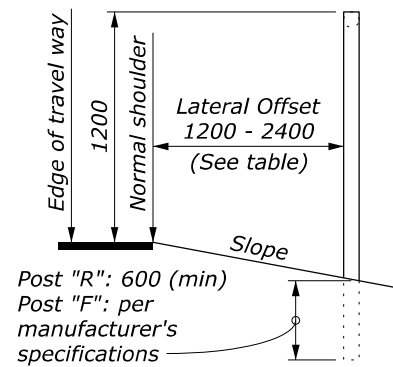

LATERAL PLACEMENT TABLE	
SLOPE	OFFSET
1V:4H	1200 to 1800
1V:6H or flatter	1800 to 2400
Curb Section	1800

TYPICAL INSTALLATION

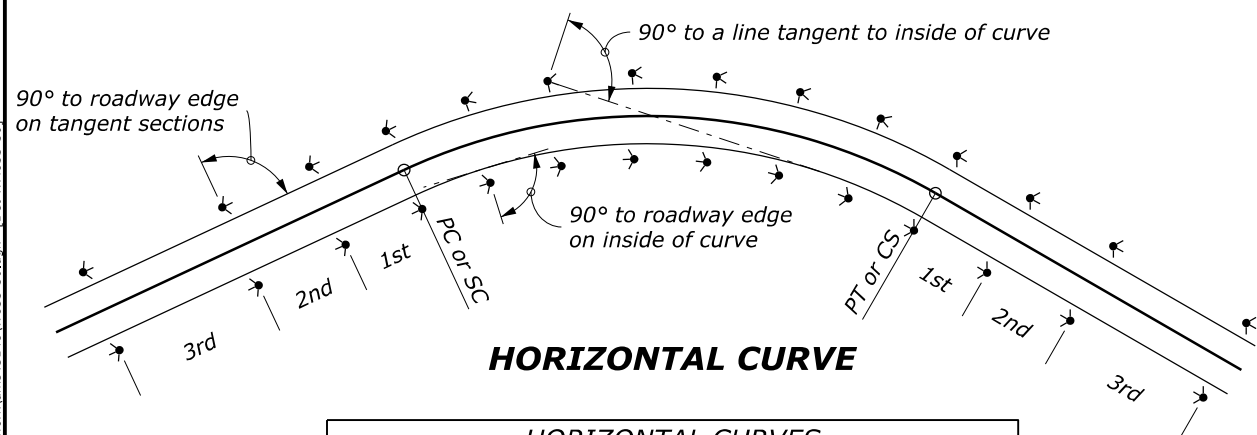

HORIZONTAL CURVE

HORIZONTAL CURVES				
CURVE RADIUS (METERS)	SPACING ON EACH SIDE OF ROADWAY (m)			
	ON CURVE	BEYOND SC, CS, PC or PT		
		1st SPACE	2nd SPACE	3rd SPACE
≥ 1900	90	160	160	160
450 - 1899	45	90	160	160
150 - 449	30	60	90	160
75 - 149	25	45	70	160
< 75	15	30	45	90

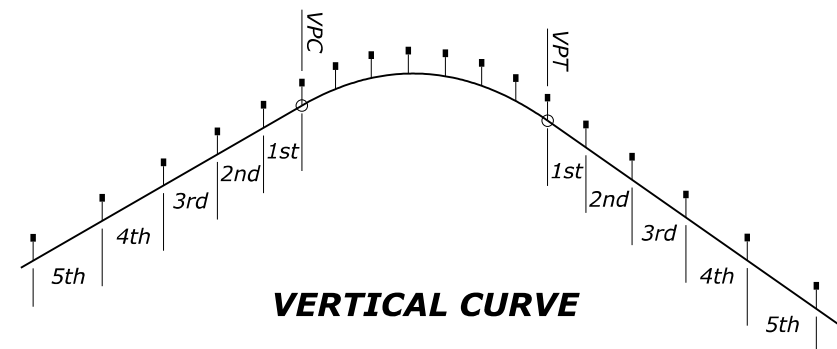

VERTICAL CURVE

CREST VERTICAL CURVES						
K	SPACING ON EACH SIDE OF ROADWAY IN METERS					
	ON CURVE	BEYOND VPC or VPT				
		1st SPACE	2nd SPACE	3rd SPACE	4th SPACE	5th SPACE
≥ 165	160	160	160	160	160	160
120 - 164	90	160	160	160	160	160
60 - 119	60	90	160	160	160	160
30 - 59	30	45	60	90	160	160
15 - 29	25	30	45	60	90	160
< 15	15	25	30	45	60	90

$K = L/A$ where L = Length of vertical curve in meters
 A = Algebraic grade change in %

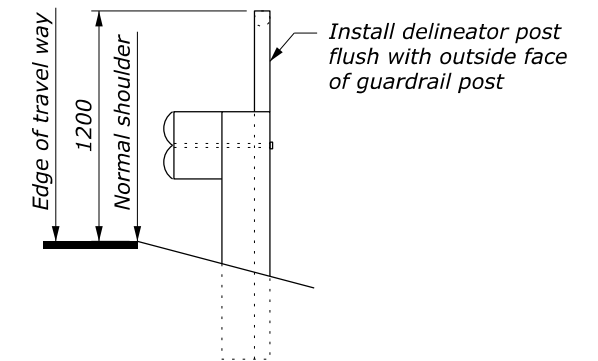

TYPICAL INSTALLATION WITH BEAM TYPE GUARD RAIL

U.S. DEPARTMENT OF TRANSPORTATION
FEDERAL HIGHWAY ADMINISTRATION
OFFICE OF FEDERAL LANDS HIGHWAY

WFLHD METRIC DETAIL

IDAHO DELINEATORS

DETAIL APPROVED FOR USE 9/2009
REVISED:

DETAIL WM633-50

NO SCALE